

PD4000Ne

TECHNICAL DATA:

CAPACITY:	4000 kg
POWER SUPPLY:	400V/50Hz
MOTOR POWER:	2,2 kW
LIFTING HEIGHT:	1895 mm
CLEARANCE:	2830 mm
2-STAGE ARMS:	712-1051 mm
3-STAGE ARMS:	793-1500 mm
OIL PRESSURE:	16 MPa
NOISE LEVEL:	<70 dB
WEIGHT:	620 kg

Electrohydraulic lift ♦ mechanical synchronization at floor level
 ♦ electromagnetic height lock ♦ automatic arm lock during lifting
 ♦ set of door protection ♦ low threshold <25 mm!



Threshold not exceeding
25 mm high!



additional overlays
protecting the car threshold



Control box with
230V electrical socket



Pneumatic connector

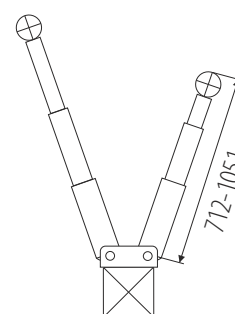
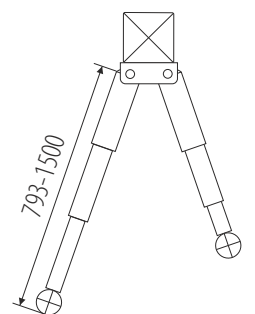
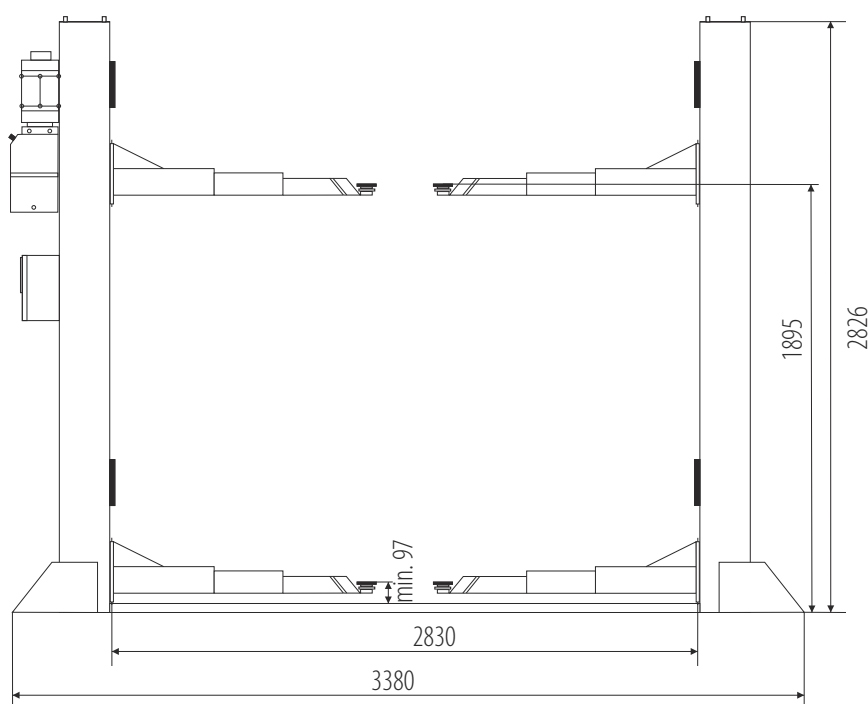

PN4000Ne

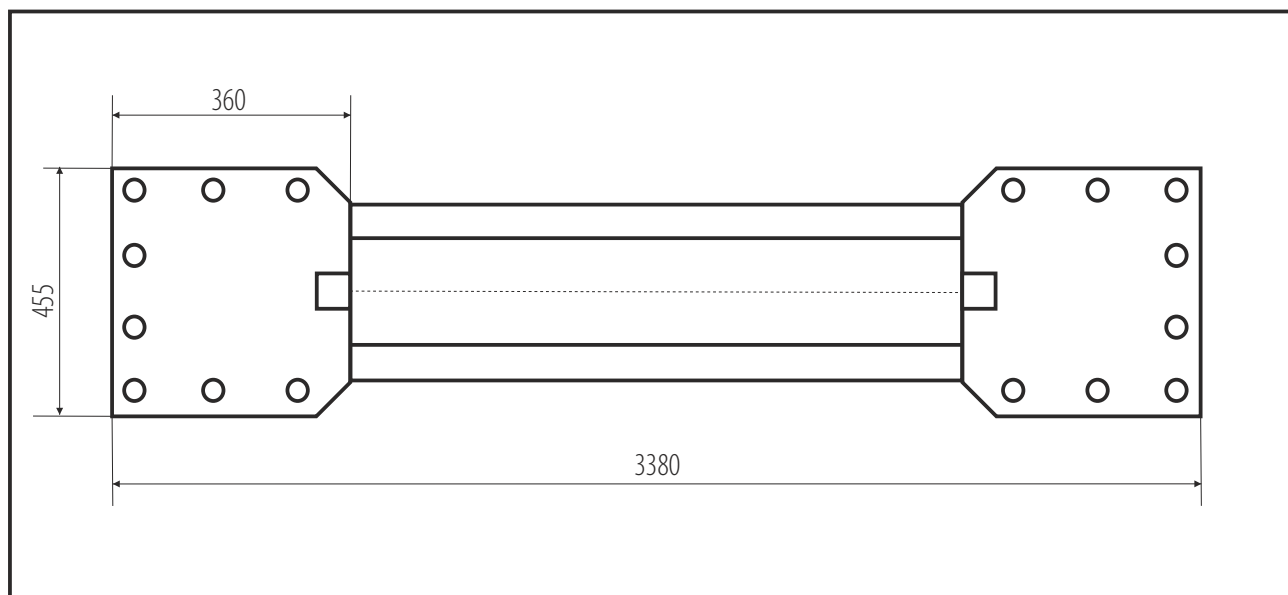
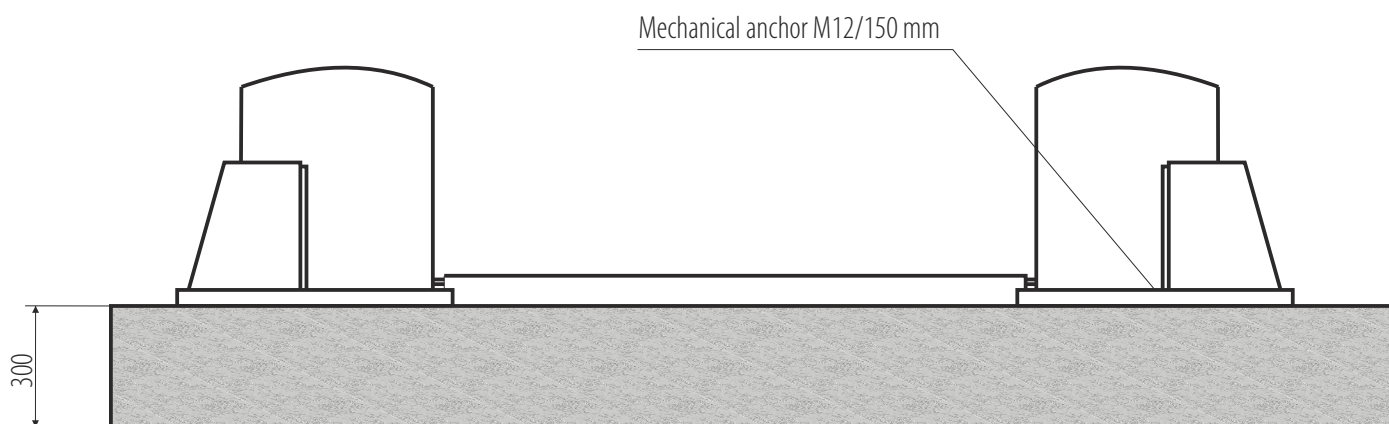

FLOOR DIMENSIONS: 4000x1500mm

INSTALLATION REQUIREMENTS:



Concrete class: B25 or C20 / 25 with a minimum mounting area: 4000x1500x300mm ♦ Acceptable floor imbalance: +/- 5mm, floor execution: 3 weeks before assembly ♦ Mounting anchors: mechanical M12 / 150 mm 10 pieces or chemical M16 / 250mm ♦ Hydraulic oil: HL32, 10.0l ♦ Power supply: 5x2.5mm cable to the place of assembly ♦ Current protection: min. 32A with 3-phase 400V / 50Hz power supply.

Installation allowed only in closed areas ♦ prohibition of using reinforcement 20 cm from the top thicker than 4mm² ♦ assembly for chemical anchors for an additional fee (submit in advance, preferably when setting the date of assembly) ♦ All connections, with particular reference to electrical connections, they must be made by authorized persons ♦ The installation must remain carried out by qualified personnel according to the rules attached in this building plan ♦ In the case of assembly by Nortec or its authorized service center, the lift must be on solid ground.